

## LED Street Light - SB05 Series

Part No.# SB05-300N-P-50-T3

### Description

This Street / Shoebox light is perfect for Area Lighting, and good for medium height round lot poles and new construction applications in industrial, road ways, seaside areas, outdoor applications. Also, it is UL certificated with high quality and 5 years warranty. Also, it's DLC 5.1 Premium listed, you will get higher rebate from DLC.

### Features & Benefits

- Unique design with appropriate heat fins, that dissipate heat to maximize the life of this fixture
- Standard exposed 1-10V dimming leads, installed Photocell Sensor and Sosen brand driver
- The driver chamber cover Clamshell design
- Reliable quality at the best price
- Replaces Up To 950W PSMH
- UL/cUL, DLC 5.1 Premium Listed

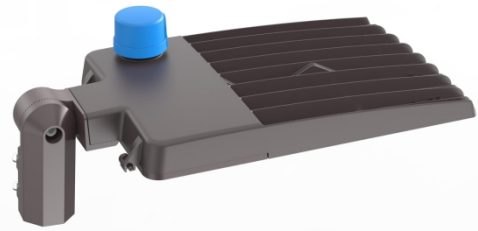

### Specifications

Input Wattage	300W
Input Voltage	120-277VAC
Efficacy	150LM/W
Lumens	45000LM
Driver Brand	Sosen
CCT	5000K
CRI	Ra>70
THD	<20%
Frequency	50/60Hz
Power Factor	≅0.95
LED Type	2835
LED Quantity	480PCS
Light Distribution	Type III

Lens Material	UV stabilized polycarbonate
Housing	Die-cast Aluminum
Operating Temperature	-40°F to 104°F (-40°C to +40°C)
Storage Temperature	-40°F to 194°F (-40°C to +90°C)
Operating Humidity	10%-90% RH
Storage Humidity	10%-95% RH
Surge Protection	L/N-PE: 10KV, L-N: 6KV
Finish	Bronze
Additional function	Photocell, 1-10V dimmable
Life Time	> 50,000Hrs (Ta=30°C@L80)
Warranty	5 Years
Waterproof Rating	WET (IP65)
IK Degree	IK08
Certificates	UL/cUL, DLC 5.1 Premium

Photometric Data

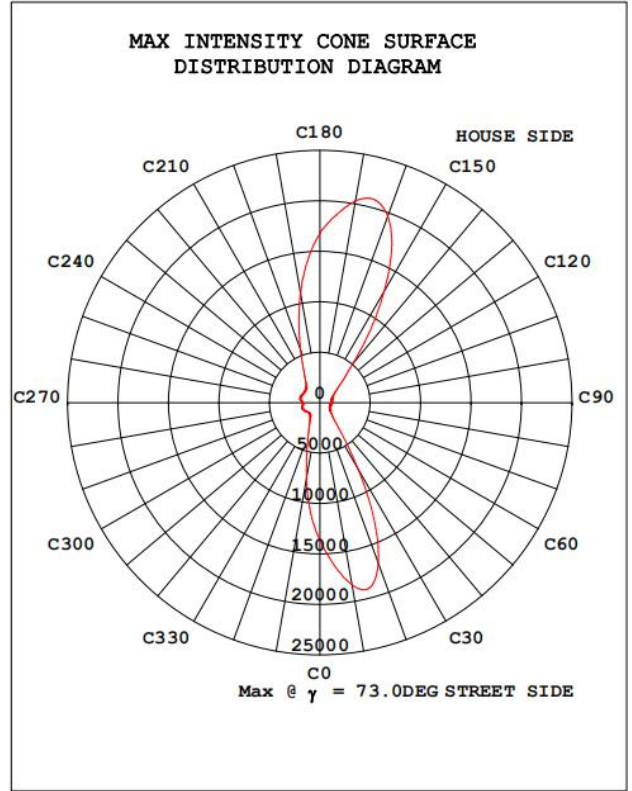
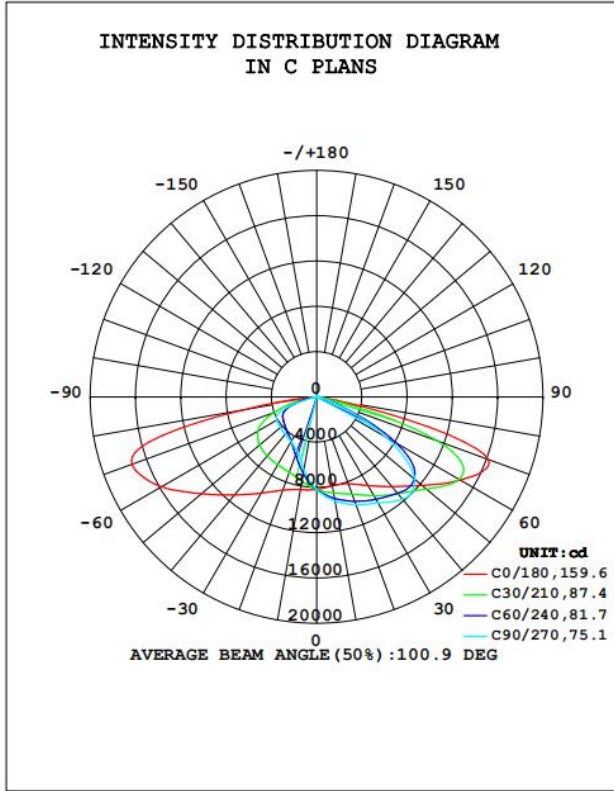

**Mdel# SB05-300N-P-50-T3**

- 26ft mounting height
- IES Classification Type 3

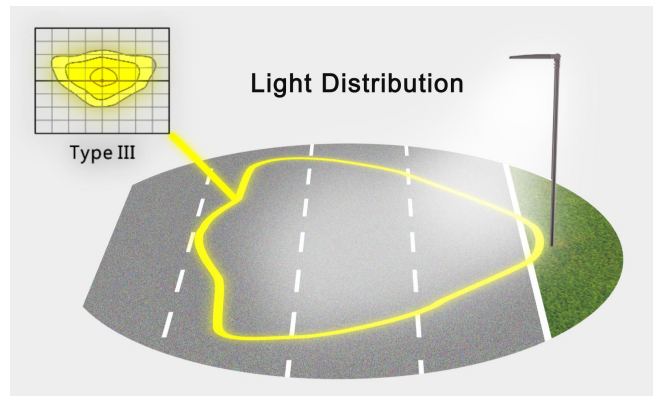

Recommended use for

- Parking Lots
- Road Ways
- General Area Lighting
- Pathway/Walkways
- Shopping Centers
- Outdoor Courts & Fields

## Product Dimension

Model Number	Length	Width	Height
SB05-300N-P-50-T3	29.56"	12.87"	2.28"
Slip Fitter Mount	Max Inner Diameter: 2.55"		

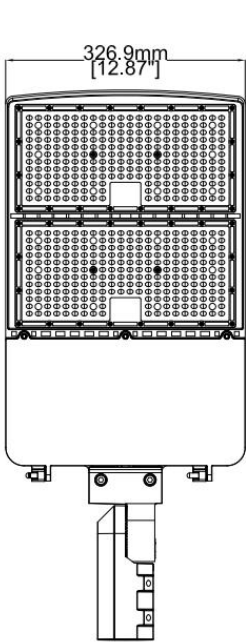

Fixture

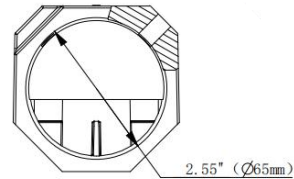
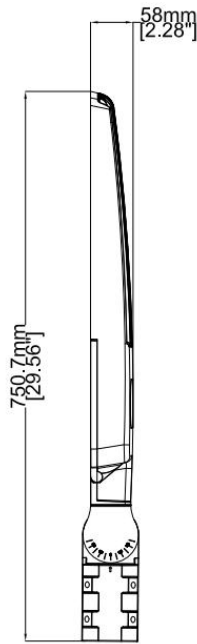

Bracket

## Packing Review

Model Number	Carton Size	Net Weight	Grow Weight
SB05-300N-P-50-T3	32.1" X 14.57" X 5.52"	15.85lbs	17.85lbs

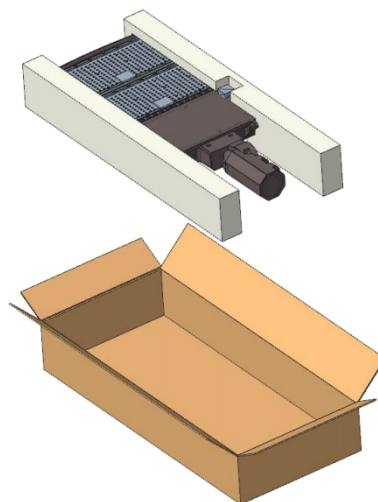
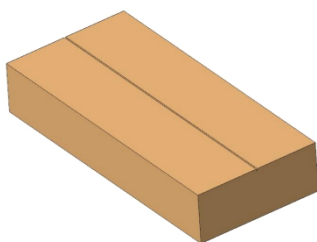

## Installation Steps

**Step 1**  
Connect the AC wire, and then insert the arm of the slim fitter to the round pole.

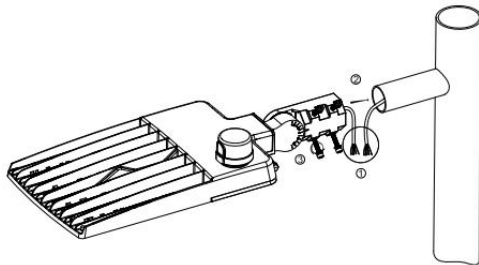

**Step 2**  
Tighten the screws on the sides of the arm and then power on.

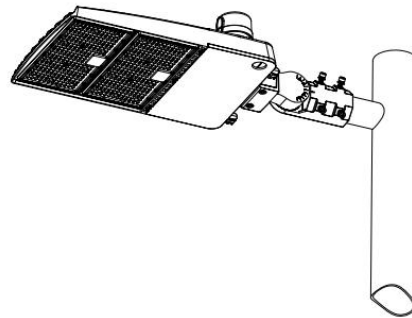

**Note:**

The slip fitter mount can be installed with 2-3/8" O.D. pole.  
The installed angle can be adjusted MAXIMUM TILT 45°, please do not intended for use as an upright.

## NOTICE FOR USER

- ☞ Please turn off power before install or change assembly parts.
- ☞ The input voltage and lamps should be matched, after connecting the power line, please make sure the wiring section is insulated.
- ☞ No-professionals, must not install and disassemble the lamps.

## TROUBLE SHOOTINGS

Trouble	Check Points
Flickering of the light	Turn off the power and turn on again in 3 minutes. If same phenomena occur, then call agencies.
Out of working	Please check the connection.